

CM-5 COLOR MONITOR
SHEET #2 (250-1043)
FAXBACK DOC # 10375

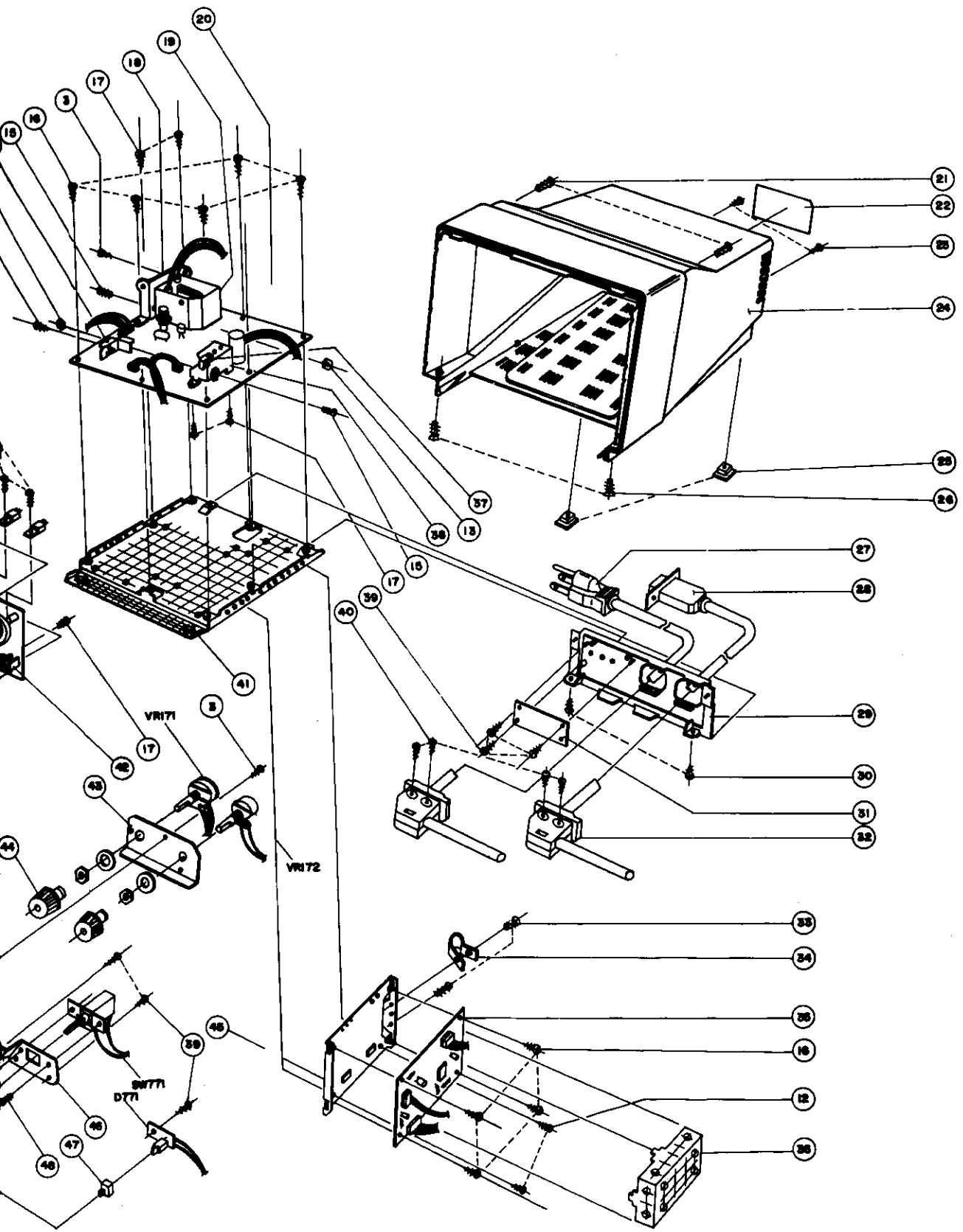

CONTINUED ON
SHEET # 1